

DETAIL A
DOME FIXATION

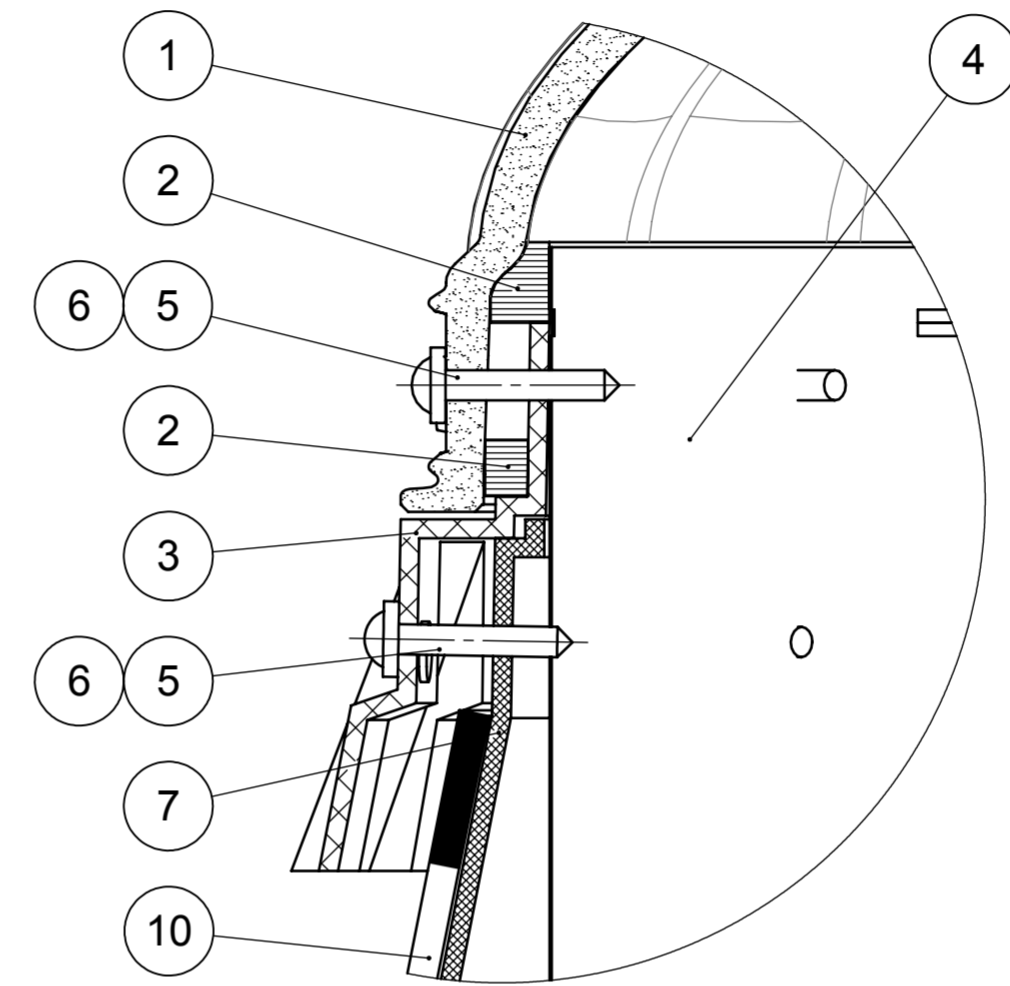

DETAIL B
ELASTIC VAPOUR BARRIER LIGHTWAY

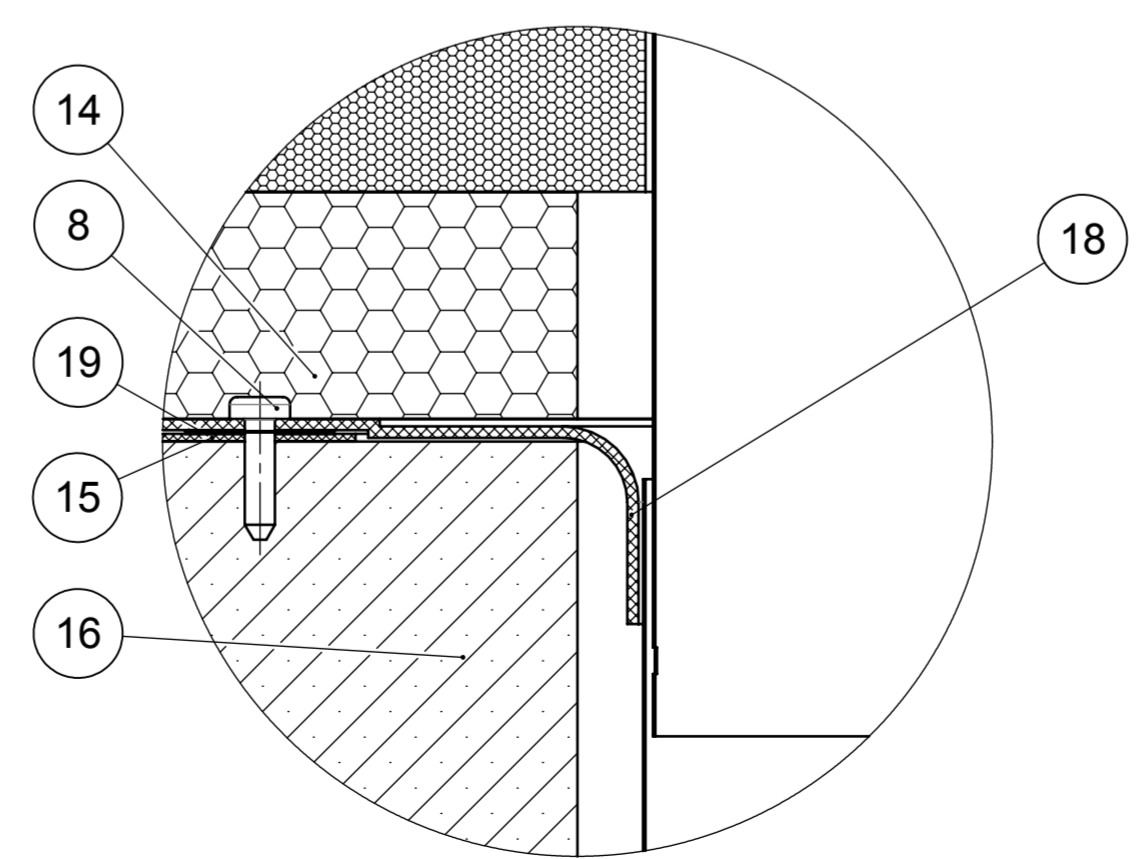



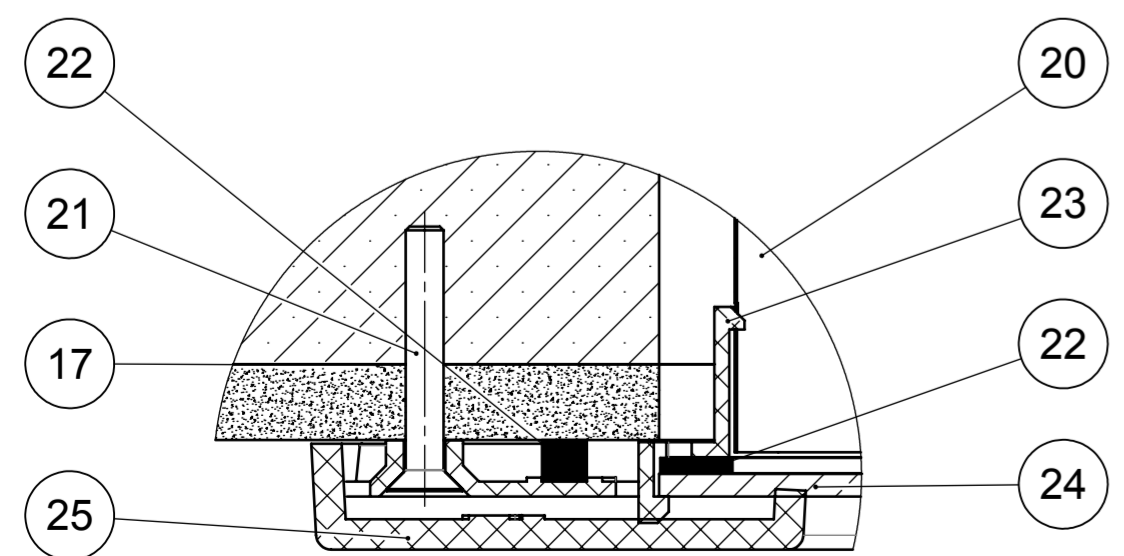

DETAIL D
DIFFUSER

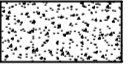

LEGEND:

POS.	NAME
1	DOME
2	BRUSHED NYLON GASKET
3	COLLAR
4	TUBE
5	SCREW
6	ELASTIC WASHER
7	FLASHING PLATE FOR FLAT ROOF
8	SYSTEM FASTENER
9	SYSTEM FASTENER
10	WATERPROOFING OF FLASHING PLATE
11	GRAVEL
12	PROTECTION FABRIC
13	WATERPROOFING OF ROOF
14	EXTRUDED POLYSTYREN
15	VAPOUR BARRIER
16	CEILING STRUCTURE
17	PLASTER
18	ELASTIC VAPOUR BARRIER LIGHTWAY
19	BITUMEN SEALING
20	TUBE INTO DIFFUSER HOLDER
21	SCREW
22	SEALING
23	DIFFUSER HOLDER
24	DIFFUSER
25	FRAME
26	ISOLATION ELEMENT BLUE PERFORMANCE

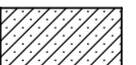
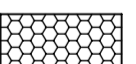
MATERIAL LEGEND:

-  PLASTER
-  PLASTIC
-  CONCRETE
-  EXTR. POLYSTYREN
-  GRAVEL

FITTING OF FIXING OF LIGHTWAY CRYSTAL SYSTEM WITH ISOLATION ELEMENT BLUE PERFORMANCE IN FLAT ROOF WITH REVERSE ORDER LAYER



NO:
CBDBP-0003-EN
VERSION:
1/2011